

Airport Perimeter Security Solutions

Application Note

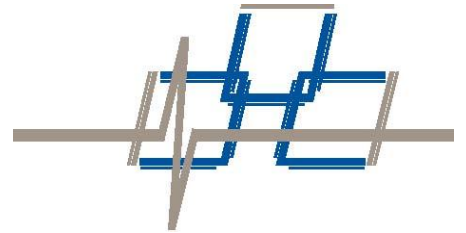

©Copyright 2012, **Fiber SenSys**® all rights reserved. No part of this publication may be reproduced or transmitted in any form or by any means, electronic or mechanical, including photocopy, recording, or any information storage and retrieval system, without permission in writing from **Fiber SenSys**®, Inc., 2925 NW Aloclek Drive, Suite 120, Hillsboro, Oregon 97124, USA.

This manual is provided by **Fiber SenSys Inc.** While reasonable efforts have been taken in the preparation of this material to ensure its accuracy, **Fiber SenSys Inc.** makes no express or implied warranties of any kind with regard to the documentation provided herein. **Fiber SenSys Inc.** reserves the right to revise this publication and to make changes from time to time in the content hereof without obligation of **Fiber SenSys Inc.** to notify any person or organization of such revision or changes.

Fiber Defender™ and **Fiber Commander**™ are trademarks of **Fiber SenSys Inc.**

Fiber SenSys® is a registered trademark of **Fiber SenSys Inc.**

Windows® is a registered trademark of Microsoft Corporation.

Fiber SenSys Inc.
2925 NW Aloclek Dr.
Suite 120
Hillsboro, OR 97124
USA

Tel: 1-503-692-4430
Fax: 1-503-692-4410
info@fibersensys.com
www.fibersensys.com



Contents

Introduction.....4

Getting Started6

Perimeter Sensors8

Fiber Optic Intrusion Detection.....8

Fiber Optic Sensor Cable.....12

Fiber Lead-in Cables13

Volumetric Microwave Sensors.....13

Integrated Security Management18

Command & Control19

Camera & Video Systems.....21

Access Control System Integration21

Long-Range Lighting Systems22

Summary23

Appendix A: Fiber SenSys APU Selection Table.....24

Appendix B: Fiber SenSys Microwave Selection Table.....25



Introduction

The Transportation Security Administration (TSA) was created in the wake of the terrorist attacks of September 11, 2001 to strengthen the security of the nation's transportation systems. The [Aviation and Transportation Security Act](#), passed by the 107th Congress on November 19, 2001, established a series of challenging and critically important milestones toward achieving a secure air travel system. Two of the many guidelines created under this law are requirements for improved access control and perimeter security measures.

The document has been created to support security industry end users, systems integrators and systems designers in light of several timely and relevant marketplace factors. The persistent threat of terrorist attacks and new global security directives are contributing to an increase in spending on airport security systems throughout the world, as recently reported by [Frost & Sullivan](http://www.frost.com/prod/servlet/press-release.pag?docid=258315033) <http://www.frost.com/prod/servlet/press-release.pag?docid=258315033> . Frost & Sullivan estimates that global airport security expenditures were approximately \$19 billion in their 2011 Global Airport Security Market Assessment. That number is predicted to grow at double digit rates for the next 7 years and will reach an estimated \$45 billion by 2018. High threat potential from terrorist attacks,

coupled with global legislation will continue to pressure airport security managers to boost their investment in security, and technology companies will continue to support these trends with efficient integrated solutions and improved industry partnerships.

Commercial or military aircraft operations areas represent high security zones requiring dependable security. Even before the increasing threat of international terrorism brought added focus to airport security, the inherent high value of airport assets and the safety requirements of air operations made security a high priority. As a result, access control and perimeter security technology solutions based on changing national and international airport security standards have evolved to address the latest design requirements.



An airport facility is saturated with electromagnetic energy; an abundance of radar and radio emissions over wide frequency ranges make security detection systems that utilize electrical or electromagnetic sensors unreliable and highly subject to electromagnetic interference (EMI). In such environments, the most reliable solutions for perimeter security applications are built on fiber-optic intrusion detection systems complemented by microwave sensors and passive infrared (PIR) alternatives. Fiber-optic sensors are immune to the effects of EMI, RFI and lightning, and microwave sensors are ideal for protecting areas where the use of fences is not practical (such as runway areas). In modern designs, system efficiency is increased through zone redundancy, such as a dual-zone fence mounted and buried sensor solution or buried cable zones combined with volumetric microwave sensors.

According to industry consultants, there are five key elements to an effective perimeter security system:

1. Redundant, complementary, minimally invasive and diverse sensor elements
2. Automatic detection: flexible alarm processing units to address unique needs required by specific locations for remote, local and zone based solutions
3. Intrusion-deterrent lighting solutions that include an automated security response
4. Command & Control: Integration software with annunciation capabilities
5. Cameras for visual verification and alarm response

A March 2012 security assessment of the Philadelphia Airport which, at the time, did not employ a perimeter security system identified that: “the (unprotected) perimeter is the weakest point in security at U.S. airports today.”¹ The Fiber SenSys, Inc. (FSI) airport intrusion detection system eliminates all of the perimeter security risks identified in this report and provides integrated technology architecture.

The purpose of this application note is to outline the most reliable and complete solutions for airport perimeter security that employ the latest in complementary intrusion detection technologies. Fiber SenSys is a full solution, perimeter security manufacturer, offering everything needed to secure facilities according to the highest commercial and military standards, including priority level one (PL-1) government configurations.

Getting Started

Typical perimeter security projects include provisions for several phases of work culminating in a successful perimeter security installation. Design and support teams are frequently engaged in the project to guide and train end users and systems integrators, and if requested, will visit the area to be secured. Getting started begins with a detailed site drawing showing building and perimeter layouts with dimensional lengths. It is best to establish preliminary security goals and objectives prior to conducting a site walk-through with consideration for the unique areas to be secured and the location of control room equipment. These can include open fields, fences, runways, fuel storage areas, buildings, information technology considerations and command & control requirements.

During the walk-through, supporting personnel observe and note details not contained in the drawing such as hills, dips and other topography considerations. They will also note any objects that would facilitate intruder bypass of the intrusion detection system, such as tall grass, trees or other vaulting aids. Analysis of the data obtained during the threat assessment and the site evaluation is used to determine the number of zones, zone layouts, intrusion detection sensor types and equipment quantities.



FSI Alarm Processor Unit (APU)

¹ Reference: U.S. House of Representatives Press Release 3/1/12 - <http://tinyurl.com/PS6-12>

Airport Perimeter Security System

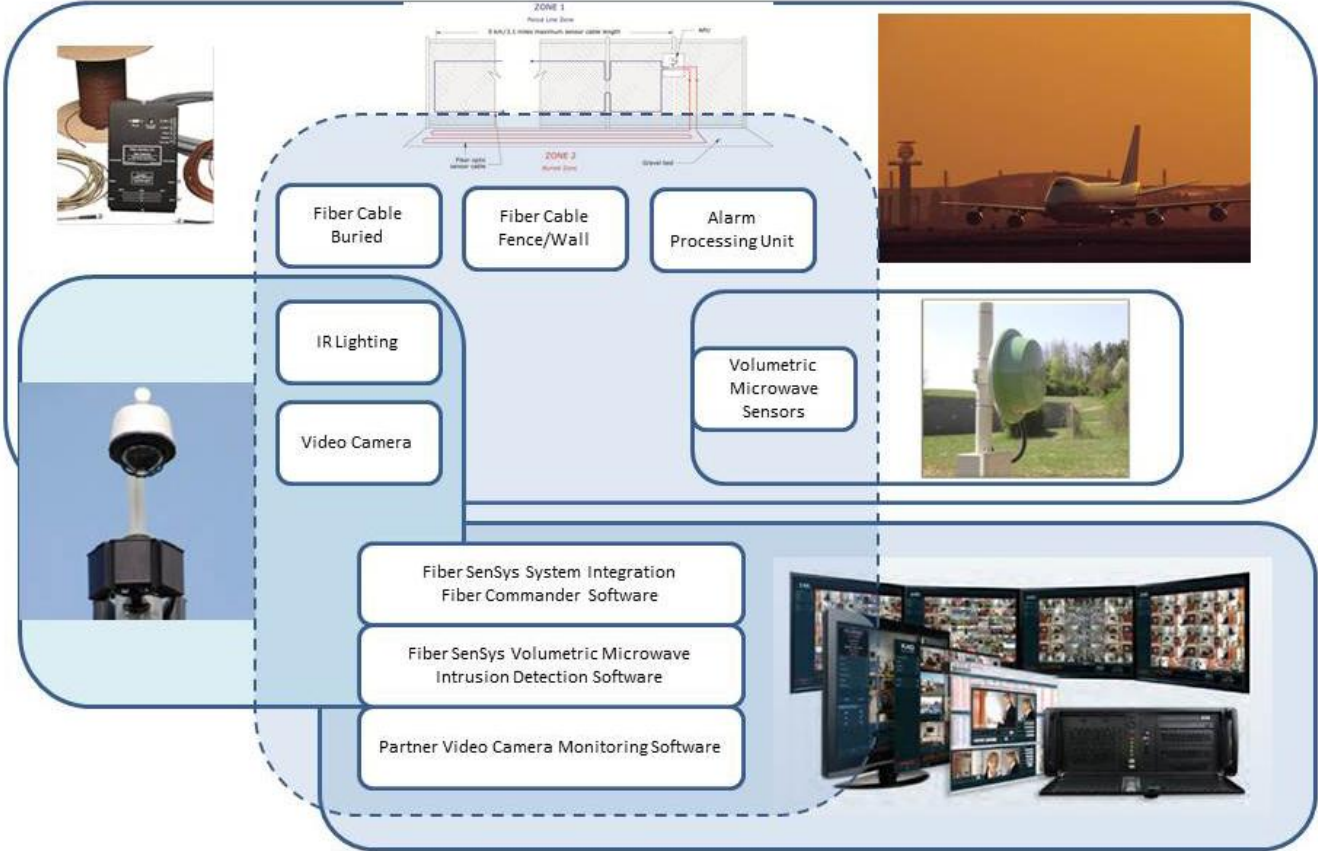

Next, a review and discussion of desired alarm response and monitoring procedures should be conducted. For example, the threat of trespass into a fenced area may be countered by a sensor buried in gravel located inside or outside the fence; the alarm annunciation capability may include an audible alarm or activation of flood lights. Incident response criteria built into integrated solutions can also include local guard and patrol services that can be notified through an auto-dialer enabled by the alarm output technology. Alternatively, alarm relay outputs and integration with the head end system may be used to trigger enhanced lighting and video assessment.

Complementary sensor technology has proven valuable in the design of a complete perimeter security system. Volumetric microwave detection typically offers the best solution for open areas where the use of fences is impractical such as runways and taxiways. Fence mounted sensors are well suited to deter and detect conditions of cutting, climbing or the use of ladders, and wall-delineated perimeter areas can also be protected in the same manner. Buried sensor cable, installed in serpentine patterns

and rated for weather exposure (and protected from insect and rodent interference) is another common security methodology. Most importantly, all choices of perimeter security technologies are outfitted with modern communications capability, such that head end / annunciation technologies can seamlessly integrate with the security sensors.

Perimeter Sensors

Fiber Optic Intrusion Detection

Fiber optic-based airport security systems have been deployed globally for more than 2 decades and serve as the foundation for modern perimeter security solutions. Fiber optic technology is widely accepted in both commercial and military air base applications. The U.S. Air Force has approved the use of fiber optic intrusion detection technology to protect some of the nation's highest security facilities where installed systems consistently deliver the highest performance. Those systems that have achieved U.S. *priority level one* (PL-1) certification are rated for protection of the most valuable assets². In addition to reliably detecting multiple intrusion attempts and tampering, fiber-optic immunity to EMI, RFI and lightning has demonstrated superior perimeter security value. Fiber optic sensor systems continue to operate smoothly and unimpeded after the effects of disruptive weather-related events.

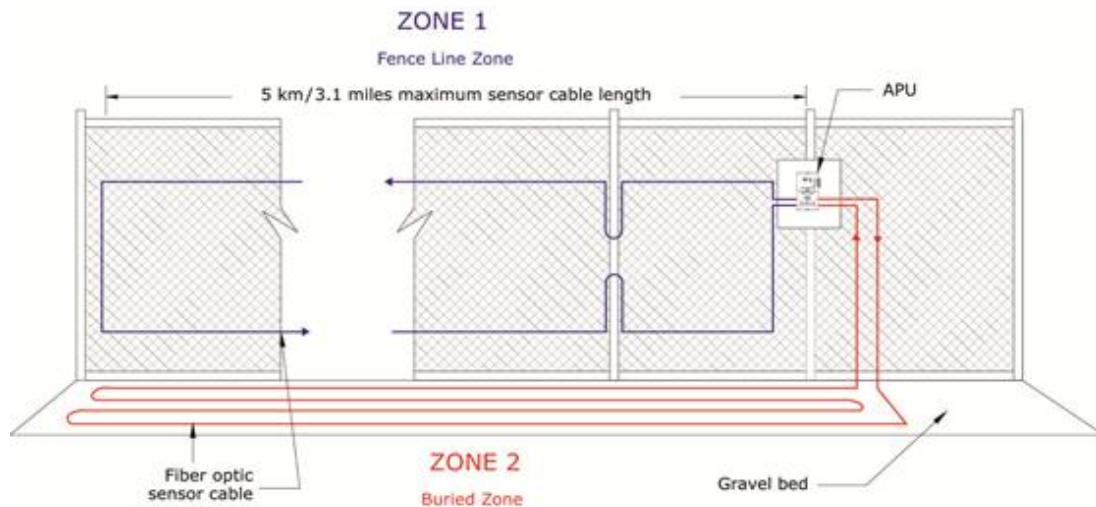

Figure 1: FD3xx APU outdoor configuration with closed loop fence and buried zones.

² The Fiber SenSys FD525, FD332 and FD342 APU's have been certified for priority level one (PL-1) installations.

The Fiber Defender™ Alarm Processing Units (APU's) from Fiber SenSys, Inc. (FSI) offer high reliability for perimeter intrusion detection solutions. Consisting of either the FD3xx or FD5xx series APUs, these all-fiber-optic intrusion detection systems are capable of detecting intrusion attempts along the perimeter.

With these systems deployed, end users will know instantly when an intruder, or a coordinated group of intruders, is attempting to breach the perimeter. The Fiber Defender APU identifies intrusion attempts along a perimeter in a zone configuration. When one zone is breached, the system instantly identifies the zone of each intrusion attempt, while continuing to monitor the other zones. Fiber Defender system installations protect aircraft and aviation equipment along the fence perimeter with zone lengths up to 5,000 meters.

With the FD34x and FD5xx series sensors, an insensitive lead-in cable provides design flexibility for connecting the APU to remotely-deployed zone(s)³. There is a significant design advantage and cost savings associated with the use of insensitive lead-in cable equating to reduced power requirements in the field. In an airport environment, perimeter fences can be protected without the requirement to provide power in the field, removing many environmental and logistical design challenges.



FD525 Alarm Processor Unit

Intended for fence line or buried applications, the Fiber Defender FD3xx series APU includes a cable design that divides a perimeter into a maximum of either 1 or 2 zones per APU. In the case of the FD525, each APU can support up to 25 independent zones. Each of the independent zones is sensitive to vibrations from intrusion attempts, and the APU interrogates each zone continuously and analyzes the optical return signals from each zone to determine whether or not an intrusion is taking place. The APU provides independent tuning of each zone for optimal system effectiveness. Additional tuning and calibration of the APU is provided by the FSI SpectraView™ software and the FD525 software suite.

³ Insensitive lead-in capability: FD525 – up to 5KM; FD34x series – up to 20 KM

For increased security, the trunk and lead-in cables of an APU can be buried and the sensing element can be installed in PL-1 configurations. The unique capabilities of the Fiber Defender APU provide the highest security in the market: detection of simultaneous events on all zones, sensing in high security configurations (PL-1), and single-point failure mitigation. An insensitive lead-in cable up to 5 km (FD5xx) or 20 km (FD34x) in length connects the APU to the remotely-deployed sensor assembly.

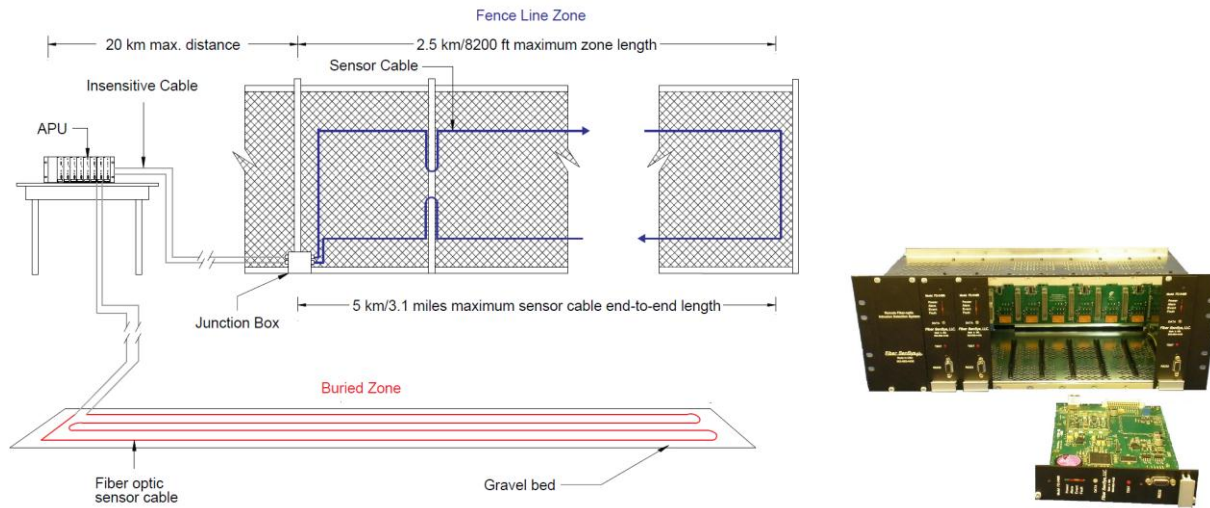

Figure 2: FD348R Indoor head-end, rack-mounted APU, shown with 3 APU cards, with area coverage of up to 8 independent zones when fully configured, into closed loop fence and buried zones.

The rack-mounted Fiber Defender model FD348R APU is uniquely suited to remotely monitor and protect multiple zones from a single, indoor server rack, with up to 8 FD348R APU's and up to 8 independent zones. The FD348R multi-zone protection typically includes a combination of buried zone and fence or wall zones. Each of the FD348R's are calibrated independently and set for optimal detection sensitivity levels. As with the other Fiber Defender APU's, the FD348R has individual zone sensitivity settings to ensure screening out of sensor signals from nuisance events, such as wind, while focusing on events caused by genuine intruders.

Remote Communication Capability

The IP/XML option configures the Fiber SenSys APU's with an RJ-45 connector, in order to provide TCP/IP connectivity with your business network and with industry-standard head end and annunciation equipment. This option enables the APU to send and receive commands while receiving detection information live, with real-time alarm data to remote monitoring stations. Additional support for

complementary technologies is enabled through the *FSI Device SDK*, a software development kit used to assist other manufacturers with FSI APU communications.

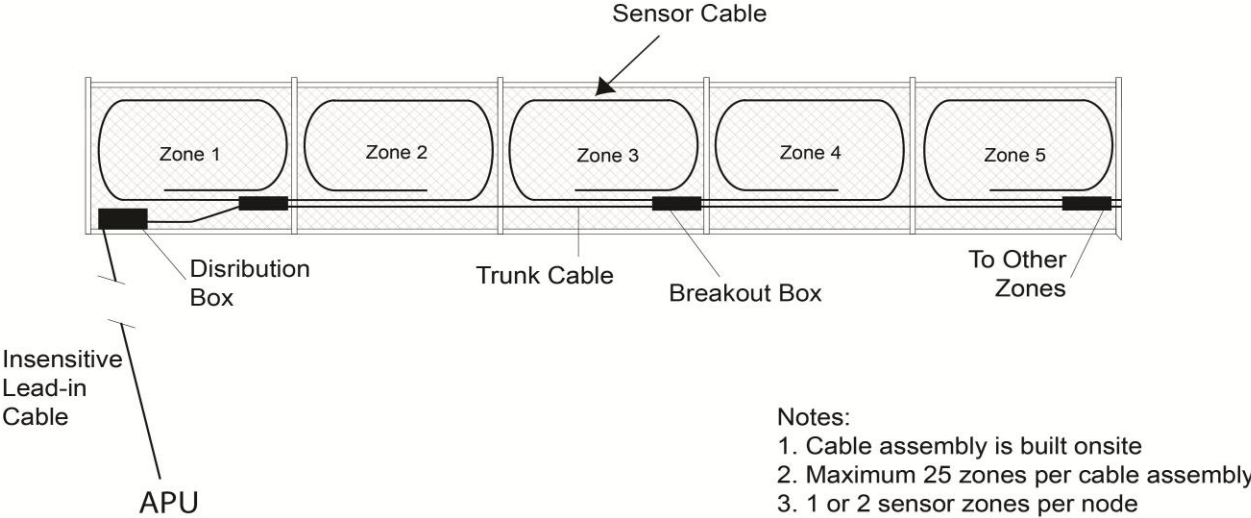

Figure 3: FD525 APU remote head-end configuration supports up to 25 distinct zones.

The FD525 APU’s rugged cable assembly consists of up to 25 individual sensor elements branching off an insensitive trunk cable. Sensor node placement along the trunk cable defines each zone location. The APU protects perimeter lengths of up to 5 km for fence applications. An insensitive lead-in cable up to five km in length connects the APU to the remotely-deployed sensor assembly.

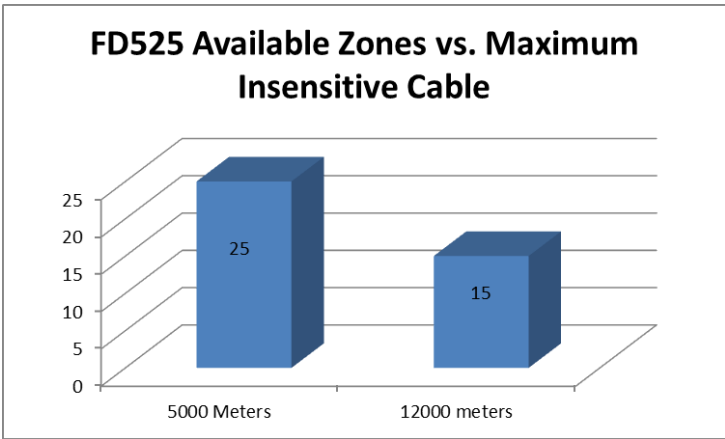
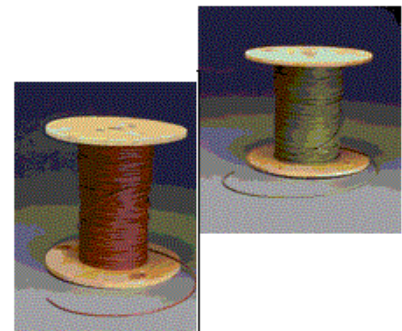

Figure 4: FD525 APU zone configurations depend on insensitive cable length.

Fiber Optic Sensor Cable

Used together with a Fiber Defender™ Alarm Processing Unit, the sensor cable forms a complete fiber-cable intrusion detection system. Immune to the effects of EMI, magnetic fields, radio frequency transmissions and lightning, the fiber optic sensor cable is a proprietary multi-mode cable designed to optimize the effects that vibration and pressure have on the conductance of light. Rugged, durable construction ensures the cable survives exposure to the harsh elements and weather conditions associated with outdoor deployment.

Two versions of sensor cable are available. The SC-3 is a 3 millimeter diameter cable for fence line and indoor applications, and SC-4, (4 millimeter diameter) for buried applications. The SC-3 sensor cable requires insertion in flexible conduit prior to deployment for fence line applications. Each sensor cable has uniform sensitivity throughout the entire length.



SC-3 and SC-4 cable

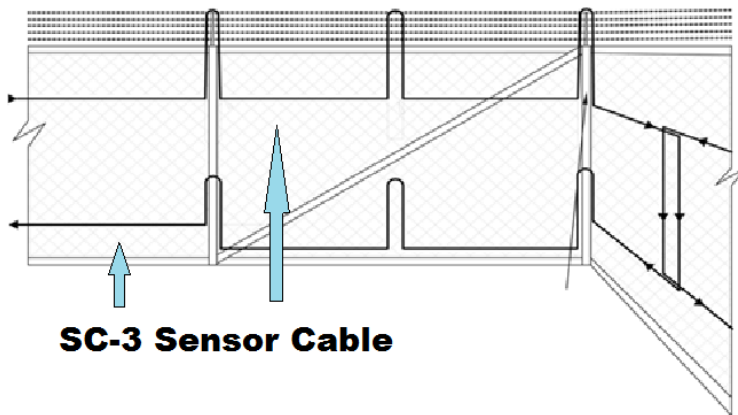

Figure 5: The SC-3 sensor cable installation in a high-security fence, corner zone.

Fiber Lead-in Cables

Relatively impervious to the effects of vibration, motion and pressure, the insensitive fiber optic cable provides a method to extend the distance between the deployed sensor cable and the Alarm Processing Unit (APU) up to 20 kilometers (12.4 miles).

Insensitive cable is available in two versions, depending upon the application: IC-3, a 3 millimeter diameter cable for above-ground applications, and IC-4 (4 millimeter diameter), for buried applications. The IC-3 insensitive cable requires insertion into protective PVC conduit prior to deployment for above-ground applications. The IC-4 insensitive cable can be buried directly without the use of conduit.

The insensitive cable consists of a standard 9 μm /125 μm single-mode optical fiber protected by a UV-resistant rugged jacket which enables it to survive in harsh, outdoor conditions. The IC-4 insensitive cable has an additional layer of outdoor jacket materials for direct burial.

Volumetric Microwave Sensors

Microwave detection sensors offer leading-edge digital technology for accurate & effective wireless intrusion detection. The FSI MD5xx series combines “fuzzy” digital logic technology that provides enhanced reliability by analyzing the received microwave signals. The microwave detection sensor offers bi-state operation, in either X-band or K-band frequencies.

For optimal performance at airports with high levels of background (RF) radiation, the MD5xx in K-band operation is the sensor of choice. It offers enhanced immunity to RF interference (RFI) that X-band only cannot.

A volumetric sensor system can be utilized as a stand-alone security technology or can be complemented by fence intrusion detection installations as a part of an integrated technology solution. The use of complementary technologies provides a wide array of perimeter protection scenarios, while maintaining a high-security, high-reliability profile.



Microwave technology effectively meets or exceeds three essential security criteria including:

- 99% in Probability of Detection (PD)
- False Alarm Rate (FAR) effectively zero; MD512x is specified at one per unit, per year, worldwide
- Nuisance Alarm Rate (NAR) of zero (per day), based on one week of recorded testing

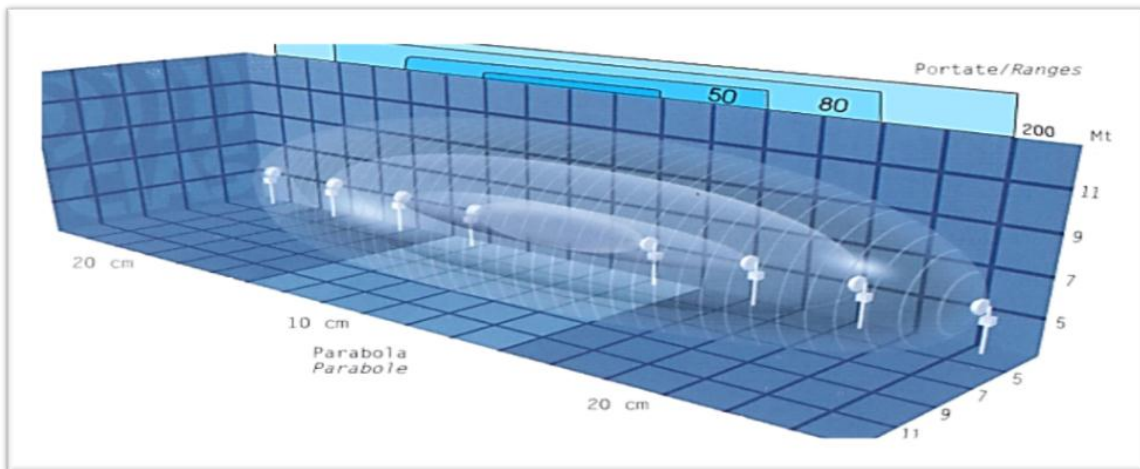

Figure 6: Volumetric microwave zone curtains provided by the MD5xx models ranging from 50 m to 500 m.

The MD5xx's internal microprocessor uses "fuzzy" logic to create behavior models based on received signals and compares with those generated by an intruder. Its digital design also provides excellent anti-masking capability to prevent tampering. The MD5xx provides reliable asset protection at distances ranging from 50 m to 500 m. The MD5xx is impervious to rapid temperature gradation within a wide temperature range, with microprocessor controlled environmental adjustments. This sensor includes an explosion-proof housing that makes it an ideal unit for areas with hazardous materials or flammable chemicals or J5-fuel mixes.

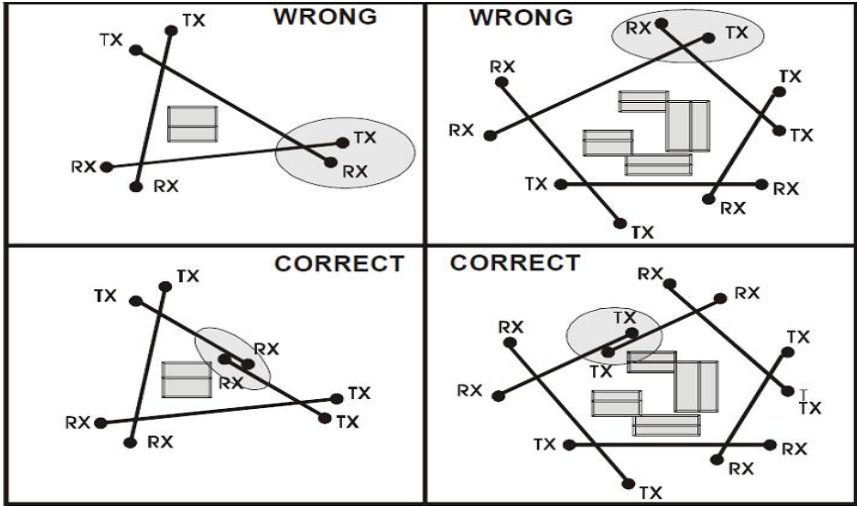

Figure 7: Illustrating examples of correct, even number of zones vs. an odd number of zones.

Volumetric Microwave Installation

There are many reasons to design a perimeter system with multiple volumetric zones. Large equipment, facility walls or other obstructions will require the larger perimeter to be divided into smaller zones of protection. The MD5xx requires a unit that transmits (Tx) and receives (Rx) for each area or coverage zone. In multiple zone applications, it is always preferable to install an even number of protected area zones to avoid crossing signals between Rx & Tx units mounted closely together. Best practices have shown that overlapping the coverage zones fills in the “holes” in the zone curtains that exist near the Rx & Tx units. Refer to the illustrated examples below, showing system installations with multiple zones crossing in the shape of a polygon. Should it not be possible to construct an even number of zones, then careful consideration must be taken to avoid signal interference. This can occur at the areas of crossing where Rx & Tx units are in close proximity, as shown in the grey circles in the figure below.

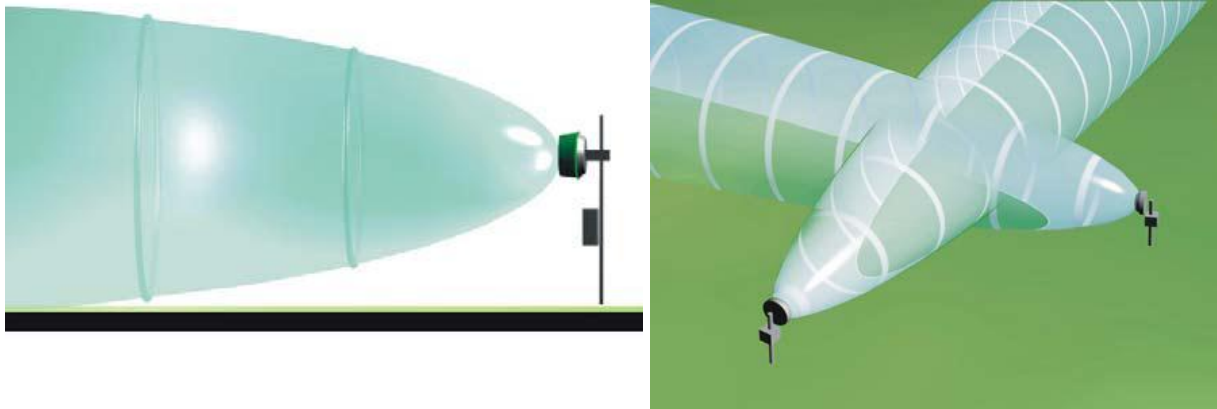

Figure 8: Illustration of optimizing zone coverage by crossing the MD5xx Volumetric sensor curtains.

When metallic mesh or link fences are present, precautions are suggested:

- ensure that the fence has been properly fixed and does not move excessively
- microwave beam should not be parallel to fence, rather create a corner with it
- moving fences behind the equipment can also cause distortions to the sensitive beam
- if the microwave beam is to be installed in a corridor between two metallic fences, the corridor width should exceed 5 meters; if less contact Fiber SenSys technical support.

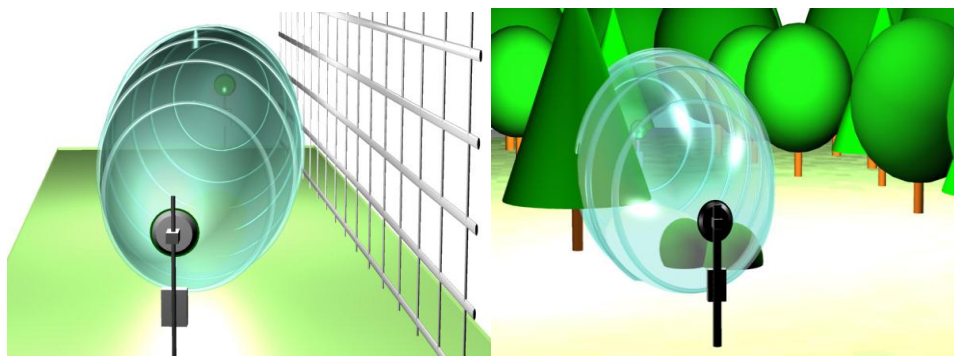
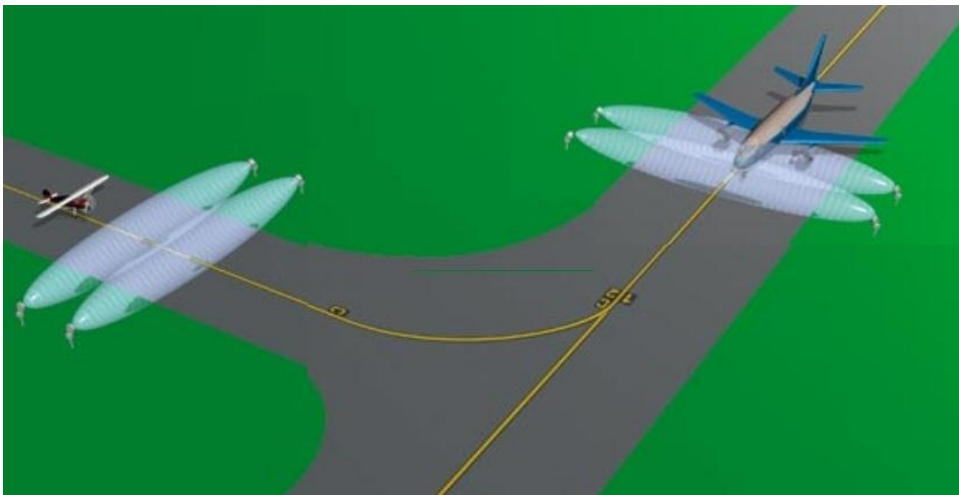

Figure 9: Avoid areas that will interfere with proper operation of the MD5xx detection zones.

In a microwave technology deployment, trees, hedges, bushes in general, should be removed if near or within the protective curtain. These obstacles vary in size and since they grow, they can intersect the zone curtain by the wind. It is advisable not to allow tall grass (more than 10 cm), into the zone curtain. Avoid ponds, longitudinal waterways, and all mutable types of ground. Ridged metal pipes, poles and posts are permitted in the zone's protective curtain.

The FSI MD5xx is powered with AC voltages from 19 VAC or 24 VAC. The unit can also be powered with 13 VDC or 8 VDC or via an optional rechargeable back-up 12 V, 1.9A hour battery. It will provide up to 12 hours of back-up power for operation. The battery charge is maintained by the internal power supply. The optional, backup battery housing is available to meet UL 94 Standards for flame resistance.



Intelligent volumetric detection has proven invaluable as a backup to fiber cable in the airport protection for: perimeter, open areas, fuel storage, hangar, parking places, and more. The volumetric barriers have also been proven for surveillance and direction of ground support movements during bad visibility (heavy fog, rain, etc.). The microwave barriers are used in airports to detect the movements of aircraft passing through the microwave beam, primarily for two reasons:

- Collision of 2 or more aircraft at runway intersections
- Head-on or tail-end collisions between aircraft moving on the taxi way.



MD512X Microwave Sensor

Integrated Security Management

Fiber SenSys proven and certified perimeter security fiber-optic sensor technologies have been integrated at the manufacturer level and are utilized to create a more robust perimeter technology solution. FSI has expanded its scope to include complementary products in partnership with industry manufacturers that enhance its fiber-optic sensor offerings.

The related components include PC command & control software with internet protocol (IP) interface capability, alarm processing units

(APU), optical lead-in cable, either single mode or multi-mode sensor cable, Volumetric microwave sensor, hazardous material self-sealing splice housings, mounting hardware and system setup optimization software tools.

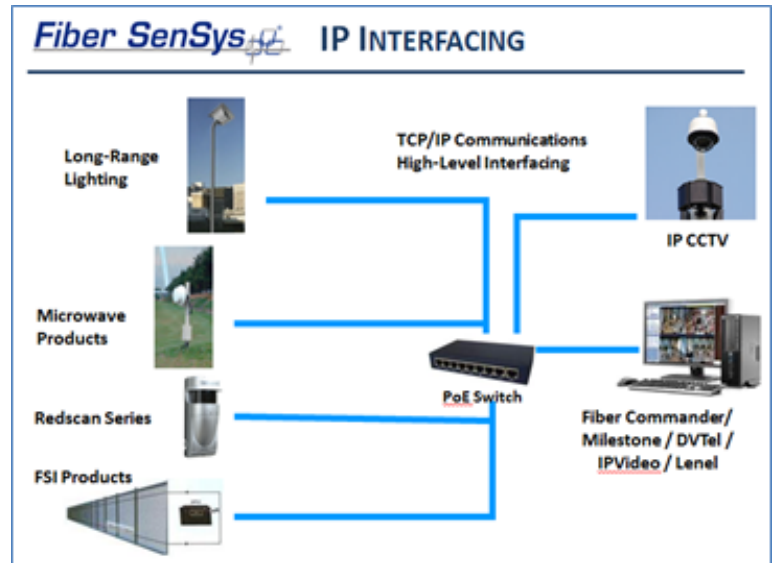

Fiber SenSys provides everything for a completely integrated perimeter security system.

- **Single integration point** – a seamless platform and architecture integrates the most common perimeter security sensors used in airport applications.
- **Real-time intrusion detection**, immediate response – event-driven alarms and automation alerts operators for an effectively measured intervention response.
- **Simplified, effective, solutions** – event verification avoids unnecessary and time consuming threat responses, simplified interface reduces operator training and reuse of existing video surveillance equipment.

Considering the unique environment specific to airports, Fiber Defender systems are suitable for protecting areas where aircraft, refueling vehicles or flammable fuel containers are stored, provided that no electrical components (the APU, power leads, etc.) are routed through the area. Please refer to the *Fiber SenSys Protecting Hazardous Material Application Note* (available at www.fibersensys.com) for deploying a system in a manner that ensures that flammable and hazardous areas are protected against intrusion, while meeting intrinsically safe apparatus requirements.

Fiber SenSys integrated security solutions provide:

- Command & Control - graphic monitoring, controls and alert notifications
- Automatic alarm processing units – with alarm priority color coding
- Cable Sensors - continuous tamper/fault detection, with nuisance reduction
- Insensitive Cable - remote operation, barrier & obstruction mediating
- Long-range lighting – deters intruders & supports camera image resolution
- Camera & Video Systems - supports new or existing video/camera infrastructure

Command & Control

Airport security systems can also include Fiber Commander® Software from FSI, a comprehensive and intelligent head end, for the integration, monitoring and control of industry-leading fiber optic sensors from FSI and complementary technology from industry partners. No other system gives you total perimeter security with the lowest nuisance alarm rate, highest probability of detection, and lowest overall cost of ownership.

Fiber Commander® offers powerful, easy-to-use, IT facilitated, integrated perimeter security management. It is compatible with the popular Microsoft Windows operating system environments. Now supporting Adam I/O, and the Milestone POE, where power over Ethernet is facilitated, Fiber SenSys is able to bring in relay contacts and network communications from third party sensors. Additionally, relay outputs can be controlled to turn on lights, open or close gates and perform other device management tasks through Fiber Commander Software.

Fiber Commander® is a complete, end-to-end solution targeting commercial & military airport perimeter security applications. The software provides real-time monitoring, command, and control automation in a single unified system.



Figure 10: Fiber Commander® provides direct interface to Fiber Defender APUs.

Fiber Commander[®] detects intrusions early and provides alarm notifications to operators, facilitating the dispatch of security forces immediately to the precise location where intrusion attempts are detected. When combined with the advanced technology of the Fiber Defender (APU), the graphical computer display highlights the precise zone locations of perimeter intrusion attempts.

Input & Output Relay Mapping

As a complement to the FSI head end integrated solution, the Adam 6060 is a networked relay module that contains relay outputs and digital inputs. A customer can use Fiber Commander to monitor remote devices connected to Adam 6060 units. Fiber Commander can be configured such that when an alarm event occurs, Fiber Commander will activate a relay on the Adam 6060. The relay will remain active until the event is acknowledged through a response or dispatch.

Unmanned mode allows Fiber Commander to operate without the need for an operator to acknowledge alarms. Unmanned mode works in conjunction with Adam 6060s and Fiber Commander's Input to output features to automate onsite lighting and cameras to simplify alarm response procedures.

Sixnet[®] SLX-5MS-4ST Managed Switches

For more complex installation requirements, the optional Sixnet[®] SLX-5MS-4ST managed switch architecture allows a customer to build a redundant fiber optic network. In this scenario, a communications ring topology is enabled as Fiber Commander monitors each switch and generates an alert when a connection has gone down.



Camera & Video Systems



The Fiber Commander® head end solution also provides a crucial link for industry leading partners in open source security video management solutions. Fiber SenSys systems are now fully compatible with most IP cameras, encoders and digital recording systems through the Commander™ SDK. Milestone® compatibility makes it easy to create high-level integration and form complete integrated solutions using other edge devices.

Fiber Commander (and its optional integrated components) is positioned as the value leader among security monitoring, annunciators and control systems. It provides the features needed for a head end solution that is priced thousands of dollars less than the competition. Fiber Commander is feature rich and simpler to use and install than other security systems that cost thousands of dollars more.

Access Control System Integration

FSI airport security systems also support access control solutions from leading industry partners, such as Lenel. OnGuard® Access is an advanced access control application that includes a feature-rich alarm monitoring module. IP-enabled controllers allow the application to extend easily to all parts of the enterprise with the appropriate degree of security at the door. OnGuard® Access offers built-in support for all card technologies including MIFARE and iCLASS smart cards, as well as biometrics and wireless access control devices.

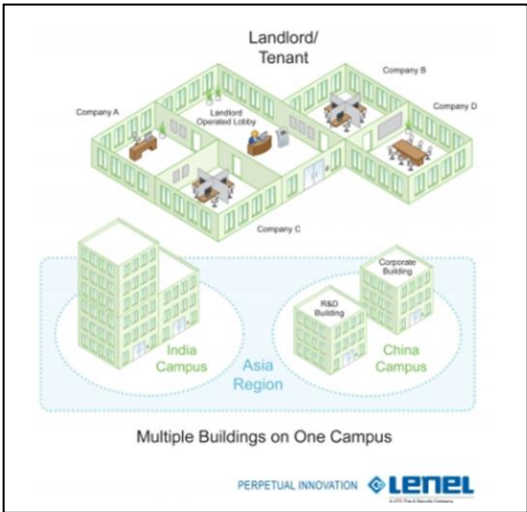

Long-Range Lighting Systems

Fiber SenSys integrated airport technology systems can also support cameras & lighting as a vital part of a perimeter security system. Illuminating the camera field of view with an Infrared (IR) and white lighting system significantly improves the performance of the camera. Since IR lighting is invisible to the human eye, it adds an element for covert camera detection. White light is useful for guard responses and to deter intruders from entering the site. Additionally, Fiber SenSys' lighting is the most energy efficient method to illuminate airports and other large outdoor areas.

Fiber SenSys LIRxx lighting systems are now fully integrated to provide intrusion deterrence with long-range LED and IR solutions for zone-based automatic lighting to illuminate areas with initial potential intrusion attempts. Lighting scatters the culprits before a crime is committed and saving money by reducing the need and priority to dispatch a security force. Solutions include:

- Lighting up to 820 feet (250m) for urban unit, safety and critical infrastructure security
- Elimination of poor lighting - critical for improving HD CCTV images in low-light areas
- APU and IP enabled lighting as a part of the integrated solution

The inherent low power consumption of solid state LED arrays result in ultra-low running costs over the life of the lamp. With an average LED life well in excess of 10 years, the LIR series can provide huge energy and maintenance savings. Impact resistant and fully weather proof (IP67) with an attractive design, LIR units can be used both internally and externally for any CCTV requirement. Fiber SenSys illuminators are supplied with a U-bracket and require 12-24V AC/DC input power. Integrated control features on the illuminator include telemetry input, power and photocell sensitivity adjust, and photocell following contact to switch D/N camera into night mode. The LIR Series is suitable for all low light installations up to 820 feet (250m).

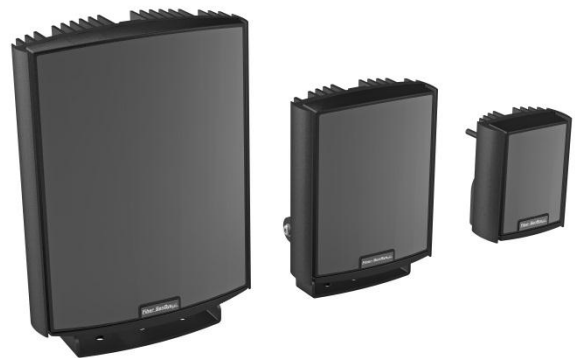

Fiber SenSys LIRxx Security Lighting

Summary

Fiber optic-based airport security systems have been deployed globally for over a decade and serve as the foundation for modern perimeter security solutions. Fiber optic technology is widely accepted in both commercial and military air base applications. New technology is revolutionizing airport security by enhancing labor-intensive and expensive security measures as identified by Frost & Sullivan, a leading industry research firm.

Security companies that provide a total security solution are becoming more desirable, through the integration of security system elements. Their report indicates that human interaction is still required, “to evaluate and implement the appropriate (threat) response”, while System Integration provides tools to increase efficiency in evaluating the most effective responses. Cohesive, single-point control over individual security system elements like: Fiber cable, Microwave, Video cameras and Lighting, helps to identify and, in some cases, eliminate or scatter intrusion threats. Technology that can be easily integrated offers “bolt-on” scalability to existing systems, while providing cost savings to new initial builds. Airport managers can begin with a basic initial security investment that can be enhanced at a later date.

Fiber SenSys, Inc.
2925 NW Alcolek Drive, #120
Hillsboro, Oregon 97124, USA
Tel: +1(503)692-4430 • Toll free (US) +1(888)736-7971
www.fibersensys.com

Fiber SenSys 
High Performance - High Reliability - High Security

Appendix A: Fiber SenSys APU Selection Table

	FD525R	RLM525	FD525	OM525	FD348R	RK348	FD342	FD341	FD332	FD331
Calibration SW Included	●		●							
Store Data Internal					●		●	●	●	●
Parameters	●		●		●		●	●	●	●
TCP/IP Compatible	●		●		●		FDIP	FDIP	FDIP	FDIP
USB /IO	●		●							
RS232 /IO					●		●	●	●	●
Form C Relay / Zone		●		●	●		●	●	●	●
Dedicated Fault Relay		●		●	●			●		●
Two Year warranty	●		●		●	●	●	●	●	●
Upgrade Firmware	●		●		●		●	●	●	●
Max Zones	25	25	25	25	1	8*	2	1	2	1
Insensitive Lead-in	12k **	●	12K **	●	20K		20K	20K		
Wind Software	●		●		●		●	●	●	●
Temperature	0 to 40° C	-40 to 70 °C			0 to 40° C	0 to 40° C	-40 to 70 °C			
Minimum Power	12w @ 12VAC	2W	8w @ 12VDC	3W	3W	25w @ 12VAC	3W @ 12VDC			
PL-1 Rated			●				●	●	●	●
NS TISSI Compliant					●					
<i>Accessories</i>										
SC-3 / SC-4	Fiber Optic sensor cable / Conduit Clad Cable									
EZ300	Conduit kit									
BB100	Breakout Box									
Hyperion	Handheld APU Calibration Device									
SLX-5MS-4ST	Sixnet® SLX-5MS-4ST managed switch									
Adam-6060	Relay Switch module									
EZ--370	Cable mounting, Metal Wire Twist Tool									
All APUs comply with CE, RoHS * With 8 cards installed ** Refer to Figure 4										



Appendix B: Fiber SenSys Microwave Selection Table

Volumetric Microwave Selection Table											
	MD505A	MD505D	MD508A	MD508D	MD512A	MD512D	MD520A	MD520D	MD525D	MD550D	
Digital MW		●		●		●		●	●	●	
Analog MW	●		●		●		●				
Range in Meters	50	50	80	80	125	125	200	200	250	500	
Operating Frequency	X-band							K-band			
Temp. Range	-35°C to +65°C (-31°F to +149°F)										
Humidity	0 to 100%										
Power	19-Volt AC, Battery/DC supply 13.8-Volt DC, 24-Volt DC										
Compliance	RoHS, CE, UL, CSA										
Volumetric Microwave Accessories											
MD-WT	Alignment Instrument for Analog barrier										
MD-TEST	Software for Digital Barrier Set up and maintenance										
AD10	1 adaptor for mounting barrier heads on 10cm poles										
MDA Back	MD analog back cover										
MDD Back	MD digital back cover										
MDA RADOME	MD analog front cover										
MDD RADOME	MD digital front cover										
Microwave Kits											
MDA Tx Kit	MD Analog TX electronic board w/ MW cavity - oscillator										
MDA Rx Kit	MD Analog RX electronic board w/ MW cavity - detector										
MDD Tx Kit	MD Digital TX electronic board w/ MW cavity - oscillator										
MDD Rx Kit	MD Digital RX electronic board w/ MW cavity - detector										
Software											
Fiber Commander	Security Command & Control with integration										

Fiber SenSys and Fiber SenSys logos are trademarks of Fiber SenSys, Inc. AN-SM-006 Rev A. 6/12